

OKI

OKIPAGE8z / 8w Lite LED Page Printer

Technical Reference

(ODA/OEL/INT)

2000-04-11 Rev.1

History of Revision

Rev.No.	Date	Corrected items			Person in change
		No.	Page	Description of change	
1	2000-04-11			Issue	E2 Yamamoto

CONTENTS

1.	CIRCUIT DIAGRAM	4
2.	COMPONENT PARTS LIST	16

1. CIRCUIT DIAGRAM

- Figure 1-1 ~ 1-9 Main Control PCB (U8S-) Circuit Diagram (Rev. 1)
- Figure 1-10 High voltage Power Supply PCB (P3H-) Circuit Diagram (Rev.1)
- Figure 1-11 High voltage Power Supply PCB (P6L-) Circuit Diagram (Rev.2)

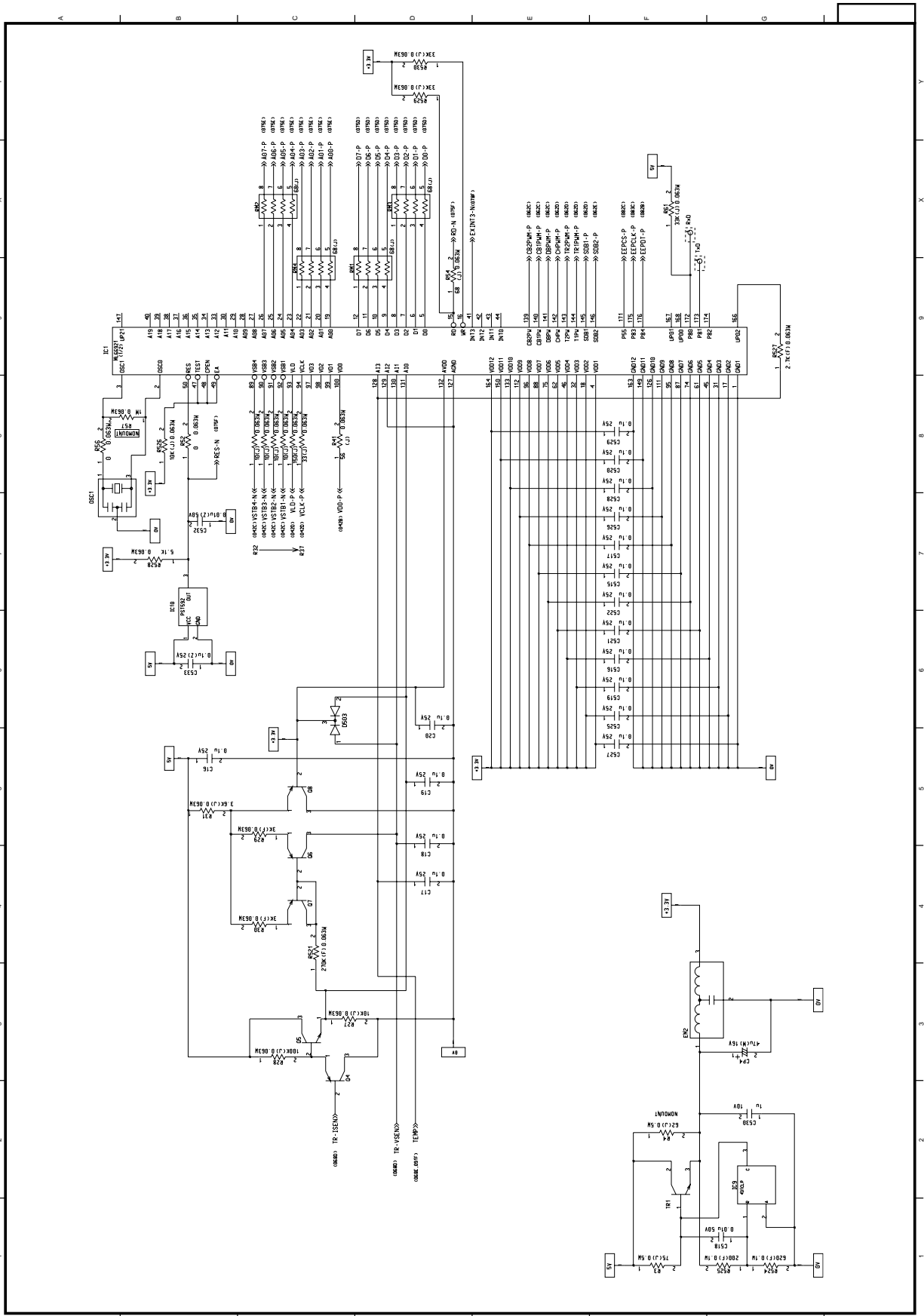

Figure 1-1 Main Control PCB (U8S-) Circuit Diagram (Rev. 1)

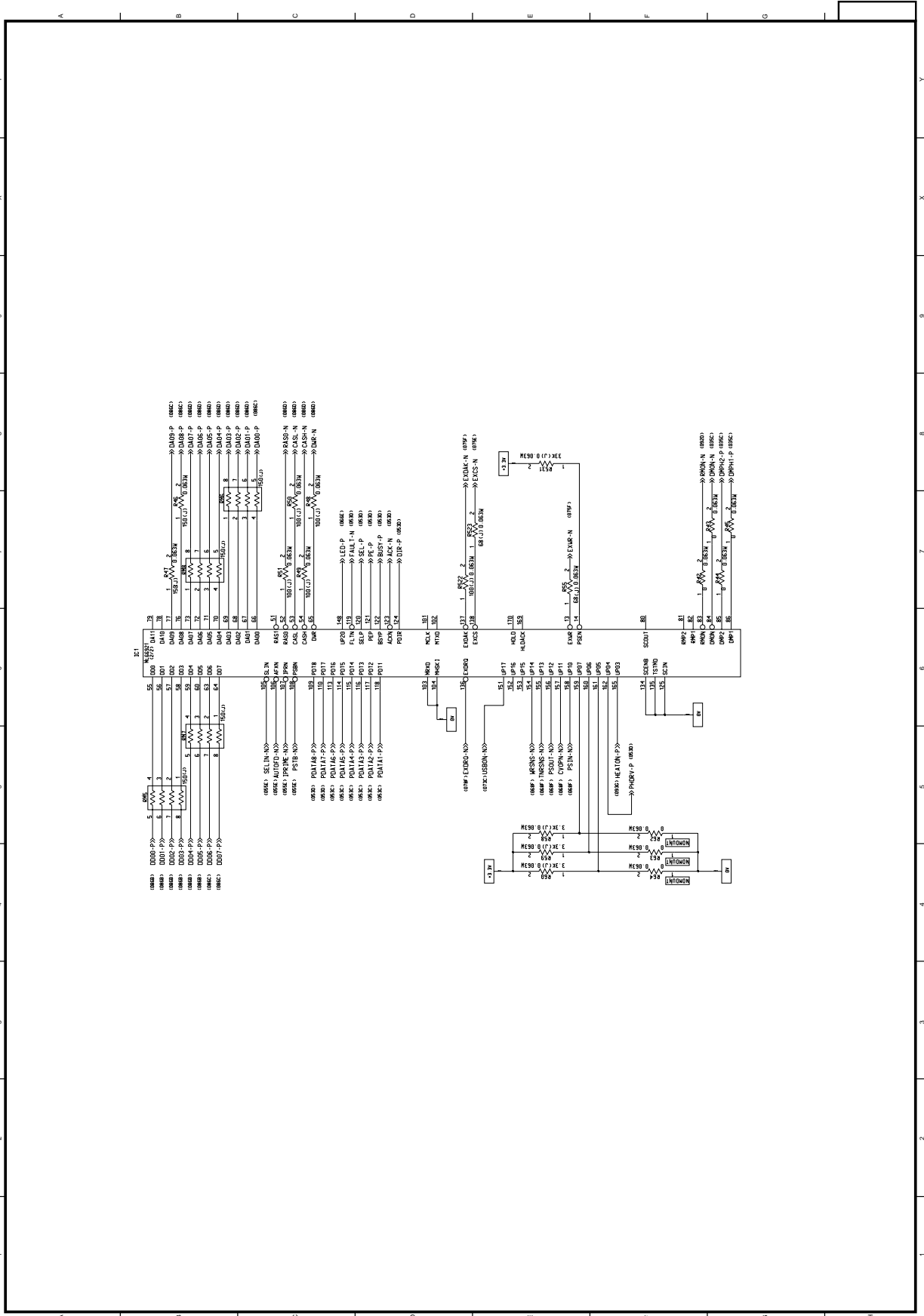

Figure 1-2 Main Control PCB (U8S-) Circuit Diagram (Rev. 1)

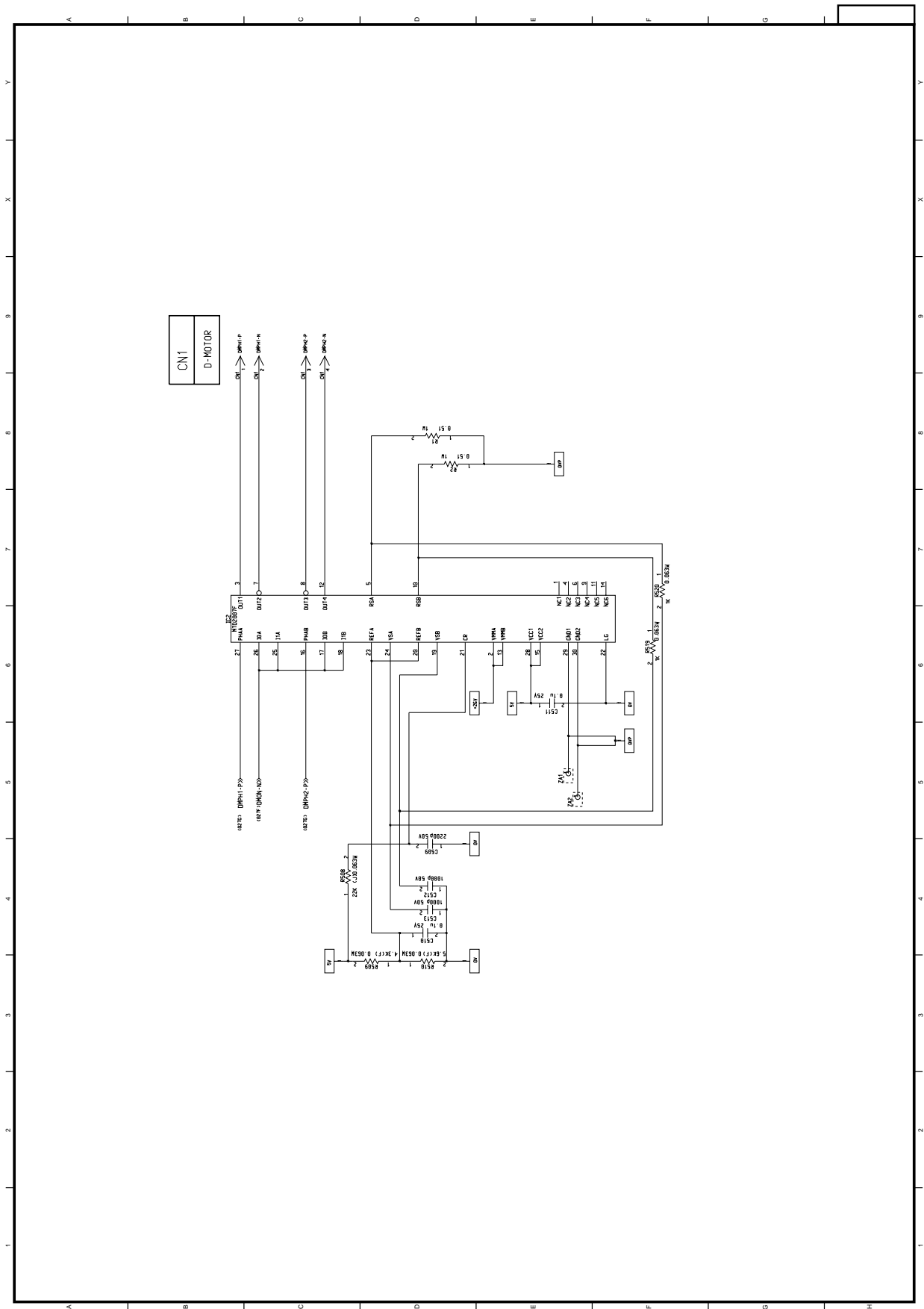

Figure 1-3 Main Control PCB (U8S-) Circuit Diagram (Rev. 1)

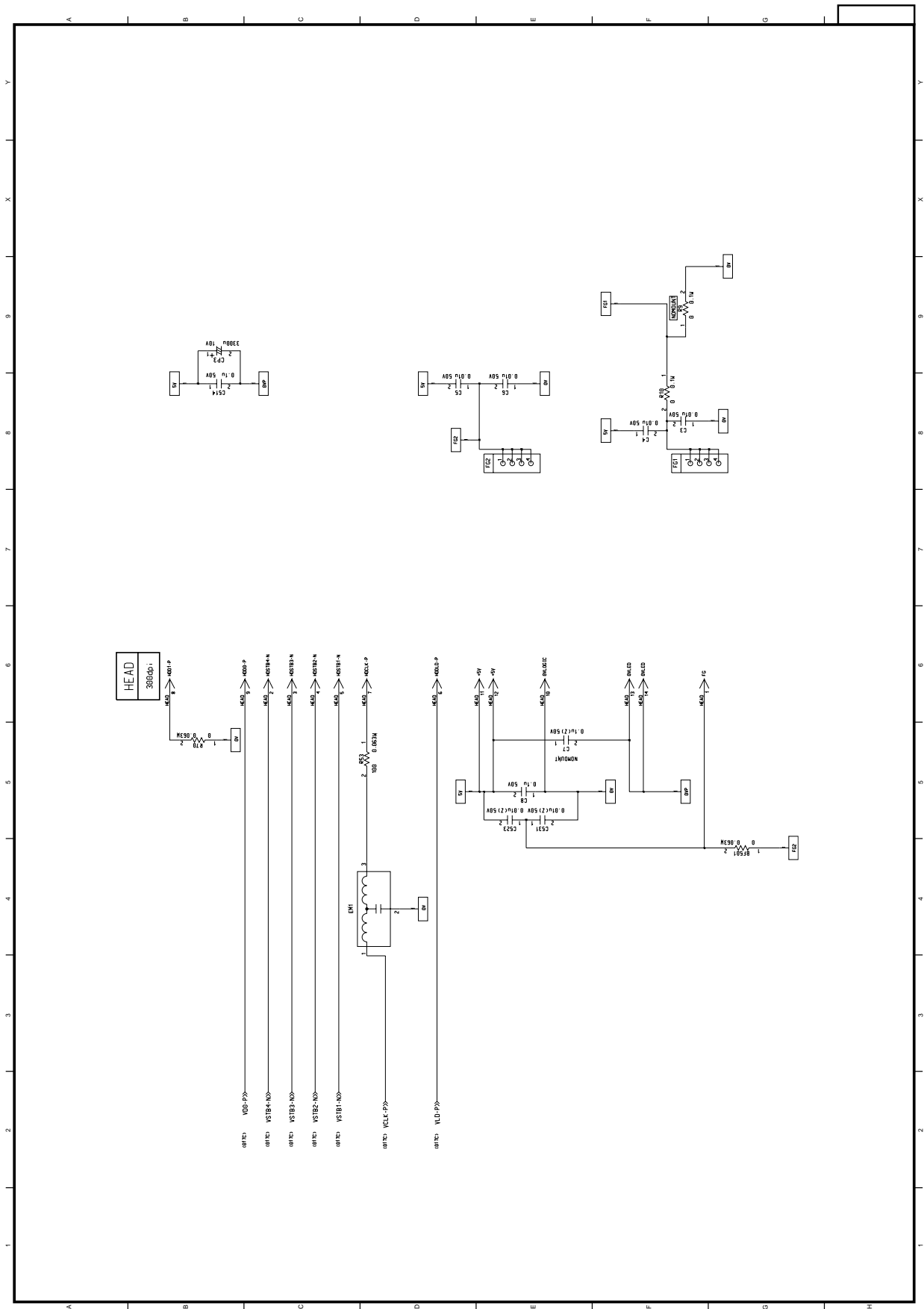

Figure 1-4 Main Control PCB (U8S-) Circuit Diagram (Rev. 1)

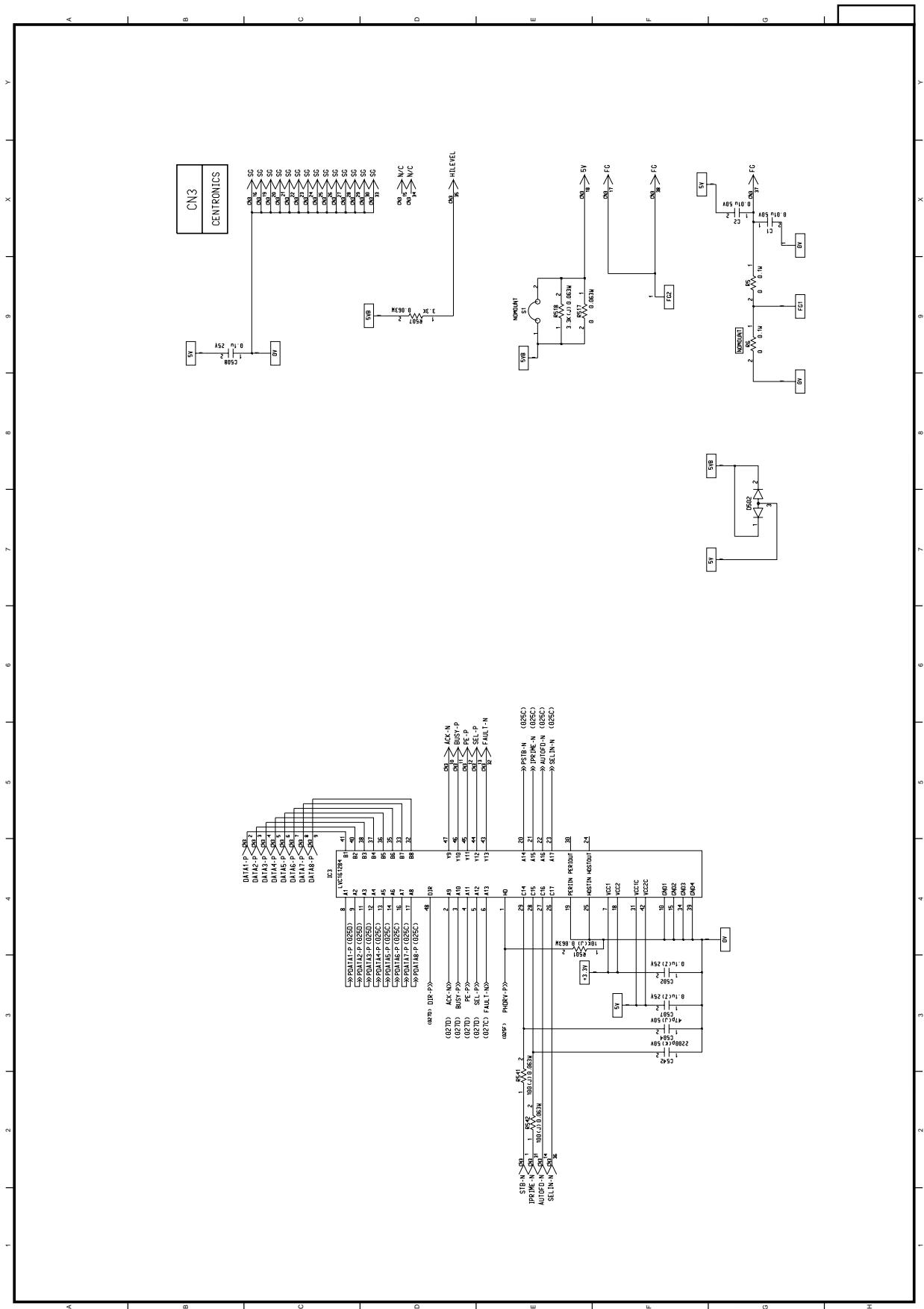

Figure 1-5 Main Control PCB (U8S-) Circuit Diagram (Rev. 1)

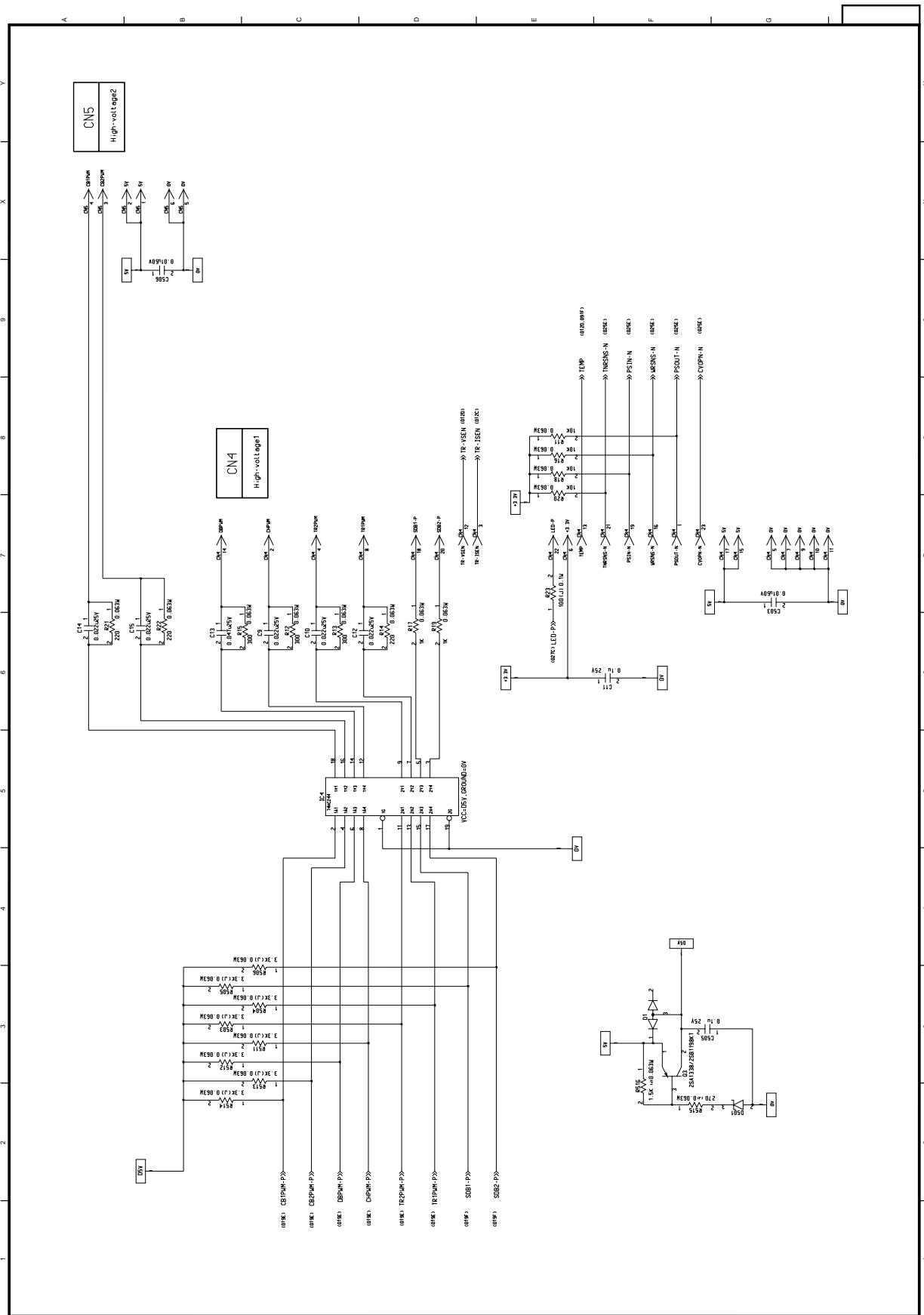

Figure 1-6 Main Control PCB (U8S-) Circuit Diagram (Rev. 1)

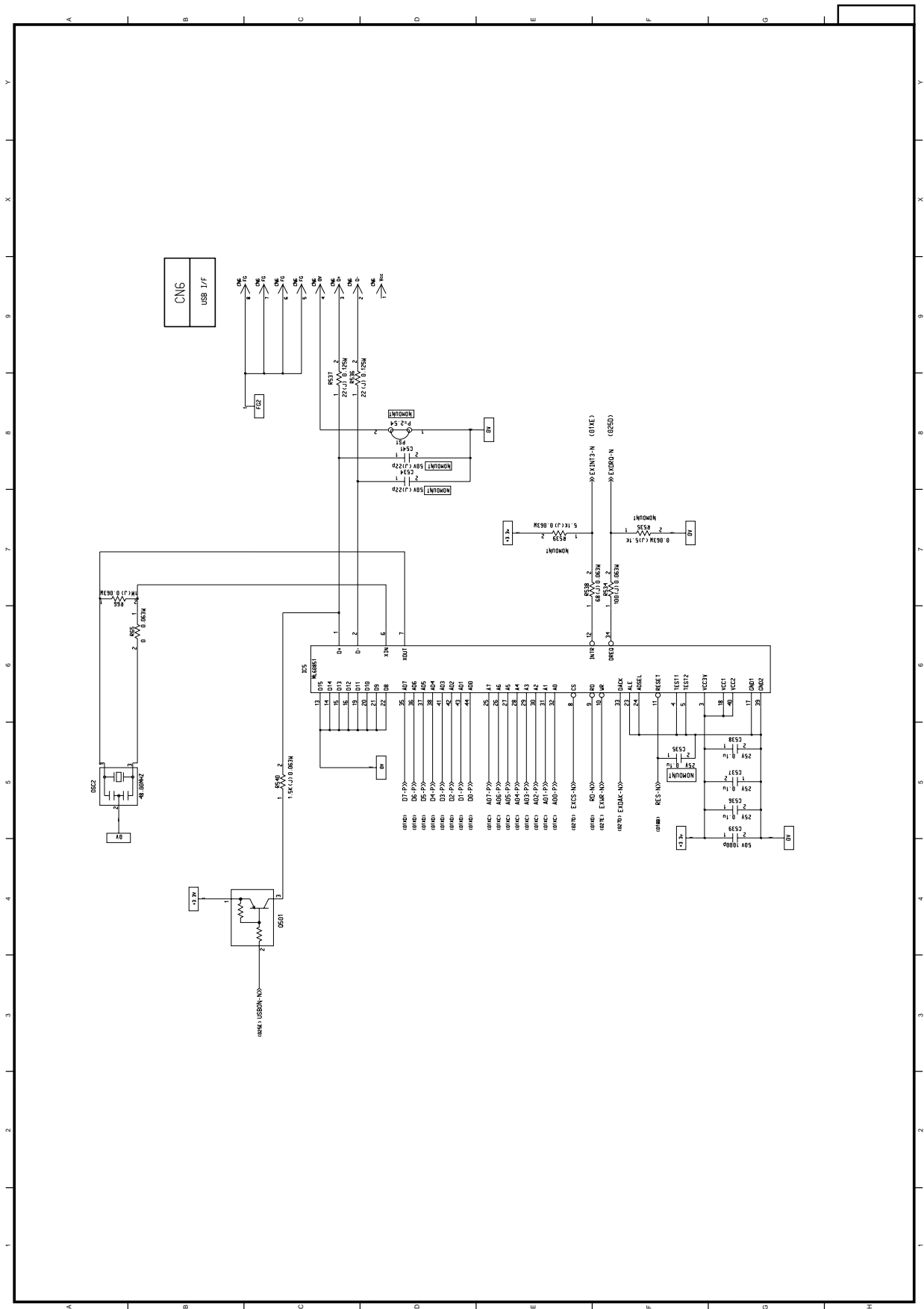

Figure 1-7 Main Control PCB (U8S-) Circuit Diagram (Rev. 1)

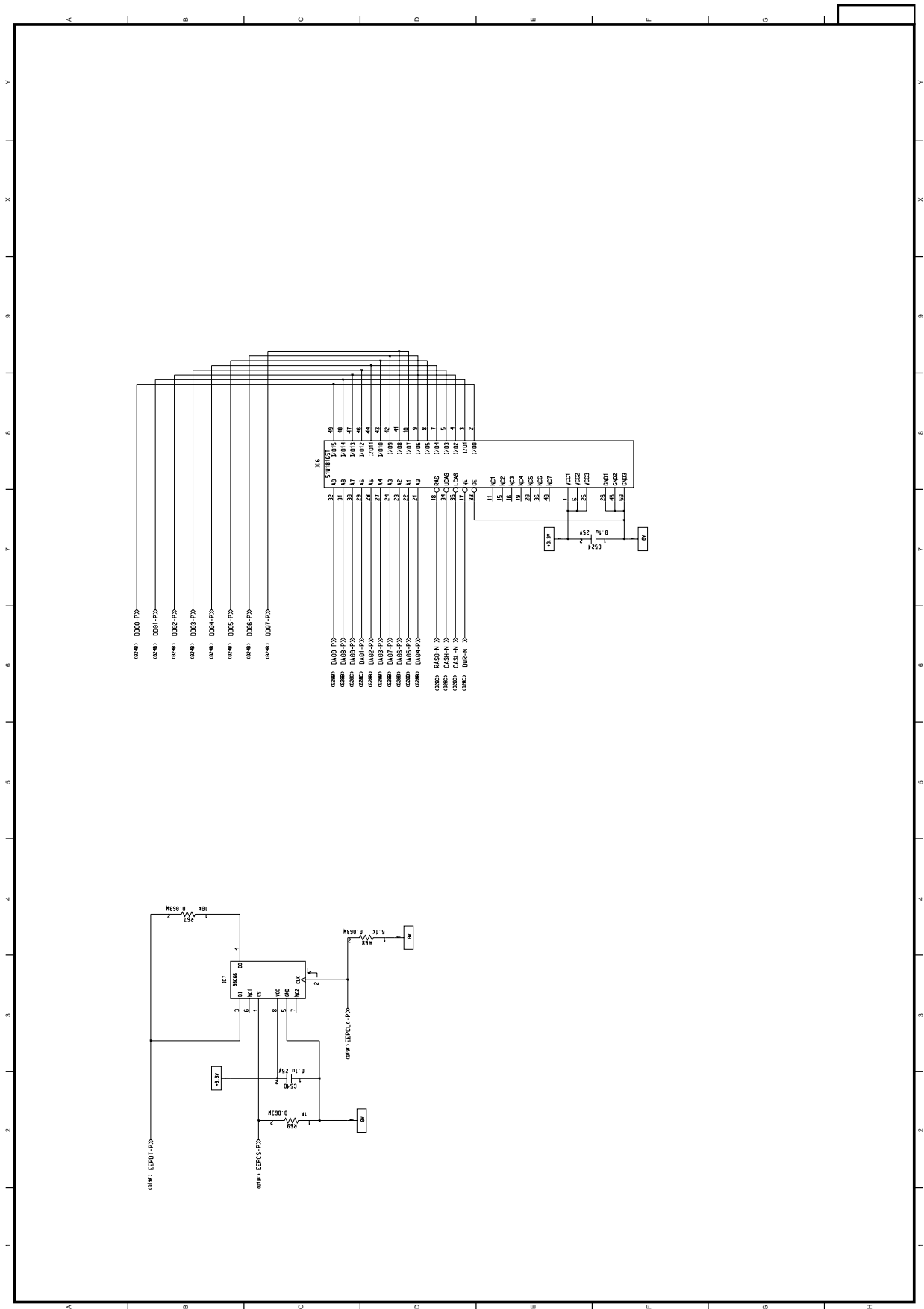

Figure 1-8 Main Control PCB (U8S-) Circuit Diagram (Rev. 1)

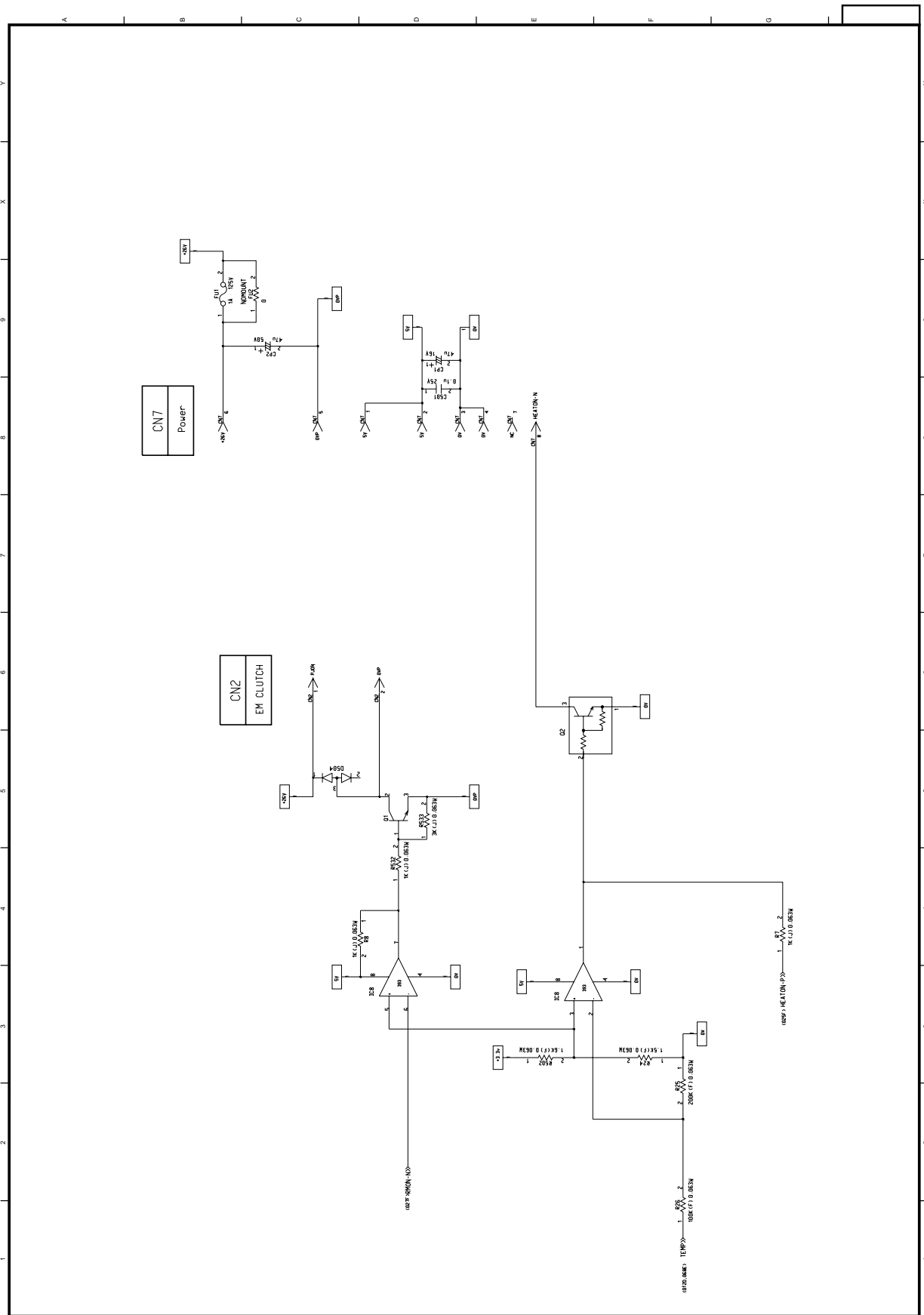

Figure 1-9 Main Control PCB (U8S-) Circuit Diagram (Rev. 1)

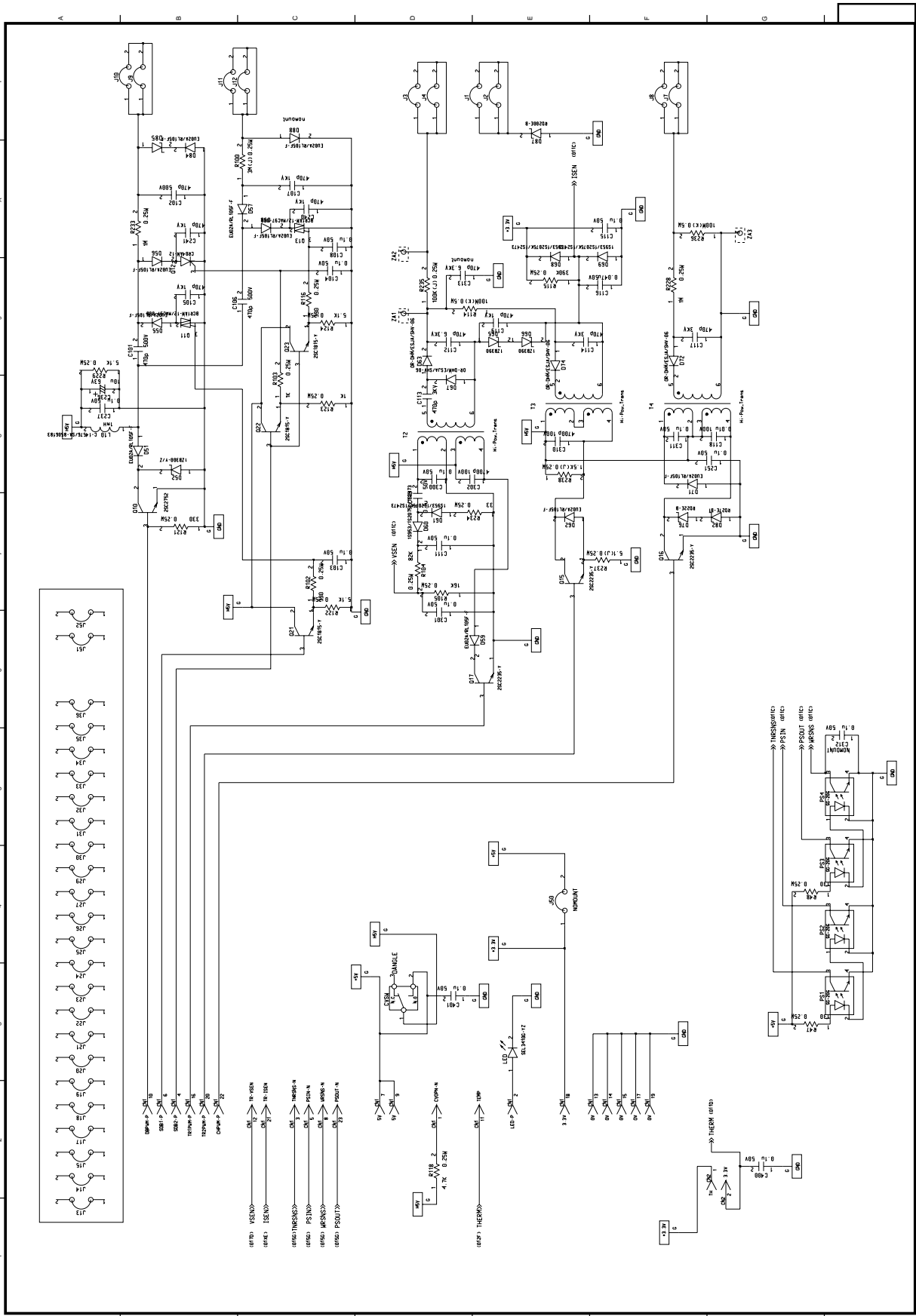

Figure 1-10 High voltage Power Supply PCB (P3H-) Circuit Diagram (Rev.1)

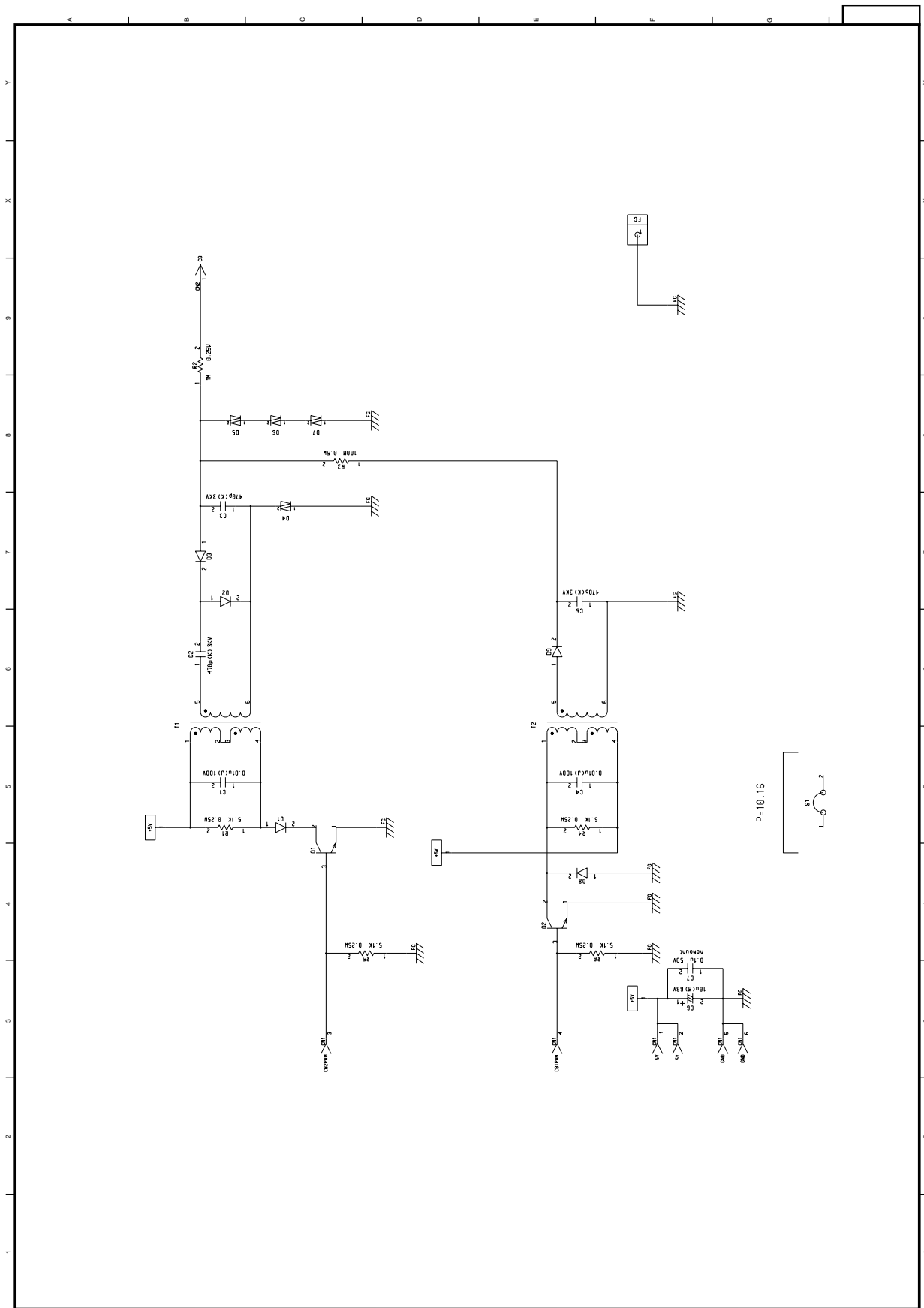
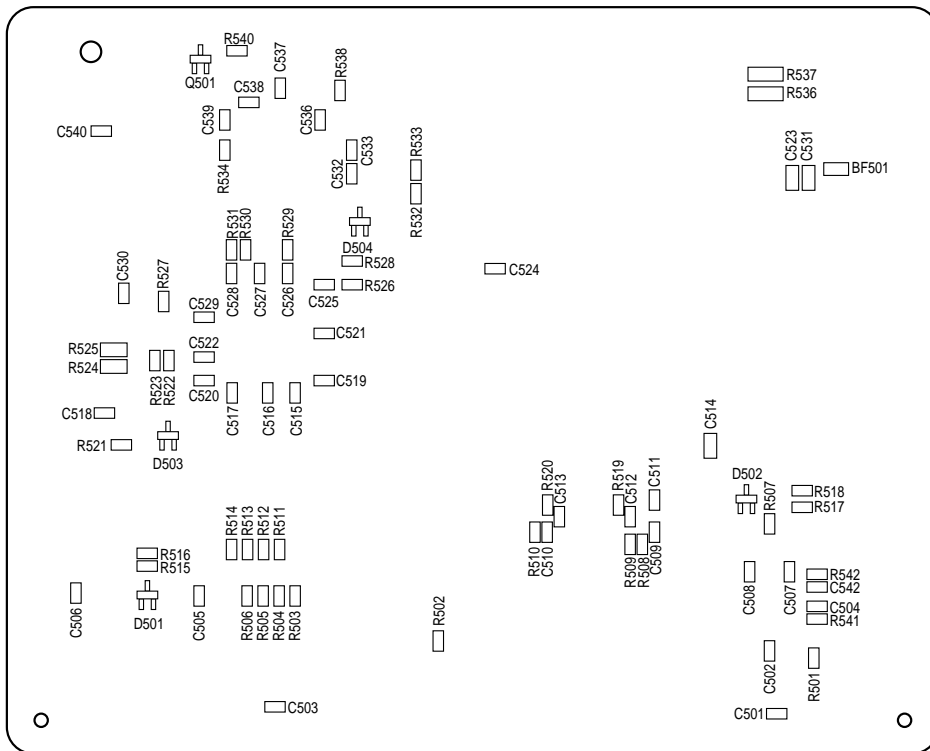
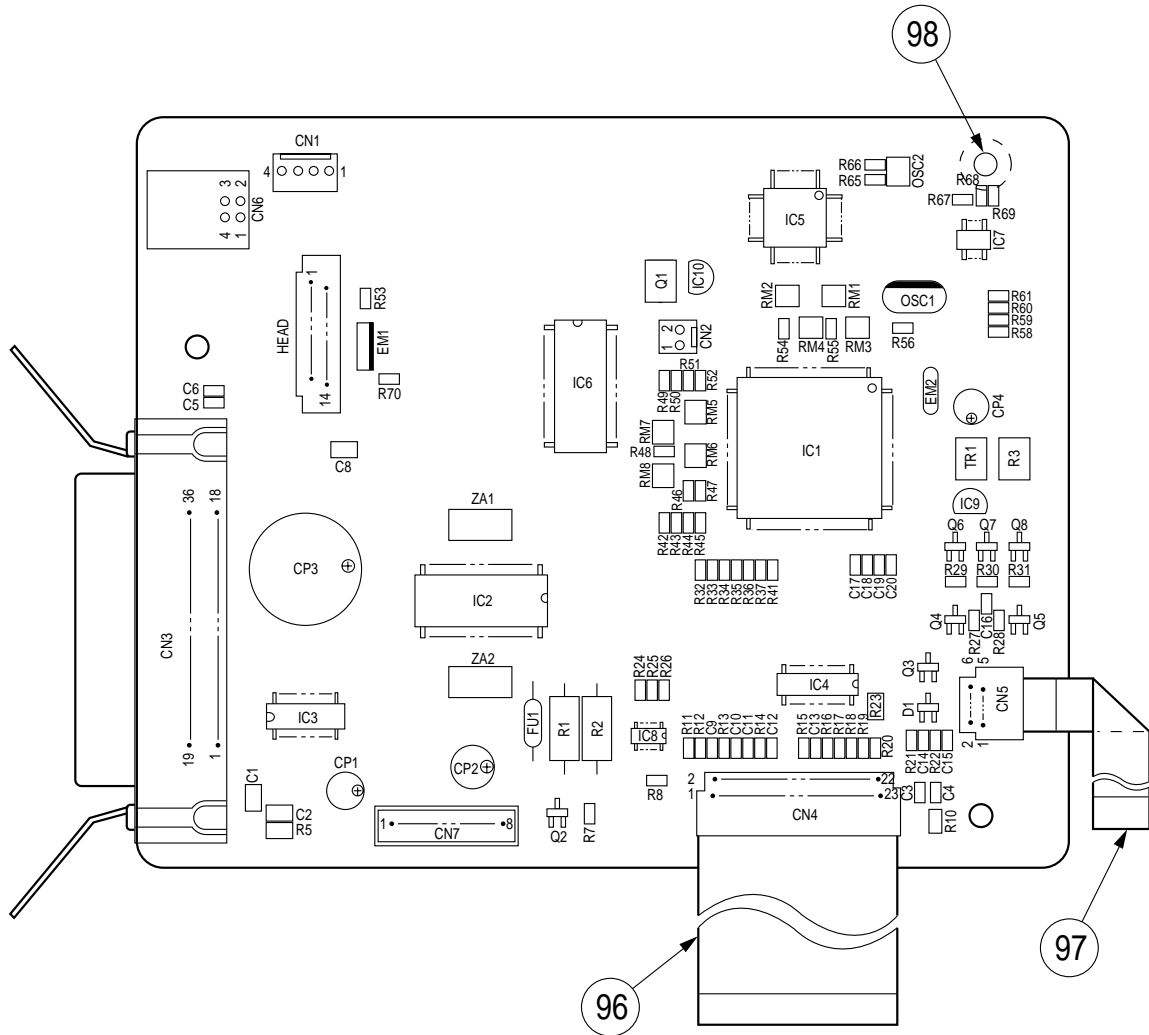

Figure 1-11 High Voltage Power Supply PCB (P6L-1/1) Circuit Diagram Rev.2

2. COMPONENT PARTS LIST

Main Control Board	(U8S PCB, Rev. 1)	41222702YA
High Voltage Power Supply Board	(P3H PCB, Rev. 1)	41039301YA
High Voltage Power Supply Board	(P6L PCB, Rev. 2)	40605601YA



**U8S Printed Circuit Board Rev.1
(41222702YA-1/2)**

**U8S Printed Circuit Board Rev. 1
(41222702YA-2/2-1/5)**

REF. No.	SYMBOL	TYPE/NAME	PART NO.	QTY	REMARKS
1	D1,D502,D504	SS100MA80VACP D-Signal -C	611A0000N0001	3	
2	D503	SS100MA80VKCP D-Signal -C	611A0000N0002	1	
3	D501	RD3.3M-B2 D-Zener -C	613A0233M0062B	1	
4	R510	CR/RK73H/ERJ/MCRF562 RES-MET RN -C	3235003F0562	1	
5	R26	CR/RK73H/ERJ/MCRF104 RES-MET RN -C	3235003F0104	1	
6	R24	CR/RK73H/ERJ/MCRF152 RES-MET RN -C	3235003F0152	1	
7	R502	CR/RK73H/ERJ/MCRF162 RES-MET RN -C	3235003F0162	1	
8	R25	CR/RK73H/ERJ/MCRF204 RES-MET RN -C	3235003F0204	1	
9	R509	CR/RK73H/ERJ/MCRF432 RES-MET RN -C	3235003F0432	1	
10	R527	CR/RK73H/ERJ/MCRF272 RES-MET RN -C	3235003F0272	1	
11	R521	CR/RK73H/ERJ/MCRF274 RES-MET RN	3235003F0274	1	
12	R29,R30	CR/RK73H/ERJ/MCRF302 RES-MET RN -C	3235003F0302	2	
13	R41	CR/RK73K/ERJ/MCRJ560 RES-MET RN -C	3235003J0560	1	
14	R32~R35	CR/RK73K/ERJ/MCRJ100 RES-MET RN -C	3235003J0100	4	
15	R48~R51,R53,R522, R534,R541, R542	CR/RK73K/ERJ/MCRJ101 RES-MET RN -C	3235003J0101	9	
16	R7,R8,R17,R19,R69, R519,R520,R532	CR/RK73K/ERJ/MCRJ102 RES-MET RN -C	3235003J0102	8	
17	R11,R16,R18,R20,R27, R67,R501,R526	CR/RK73K/ERJ/MCRJ103 RES-MET RN -C	3235003J0103	8	
18	R28	CR/RK73K/ERJ/MCRJ104 RES-MET RN -C	3235003J0104	1	
19	R66	CR/RK73K/ERJ/MCRJ105 RES-MET RN -C	3235003J0105	1	
20	R36,R46,R47	CR/RK73K/ERJ/MCRJ151 RES-MET RN -C	3235003J0151	3	

**U8S Printed Circuit Board Rev. 1
(41222702YA-2/2-2/5)**

REF. No.	SYMBOL	TYPE/NAME	PART NO.	QTY	REMARKS
21	R516,R540	CR/RK73K/ERJ/MCRJ152 RES-MET RN -C	3235003J0152	2	
22	R14,R21,R22	CR/RK73K/ERJ/MCRJ221 RES-MET RN -C	3235003J0221	3	
23	R508	CR/RK73K/ERJ/MCRJ223 RES-MET RN -C	3235003J0223	1	
24	R515	CR/RK73K/ERJ/MCRJ271 RES-MET RN -C	3235003J0271	1	
25	R12,R13,R15	CR/RK73K/ERJ/MCRJ301 RES-MET RN -C	3235003J0301	3	
26	R533	CR/RK73K/ERJ/MCRJ302 RES-MET RN -C	3235003J0302	1	
27	R37	CR/RK73K/ERJ/MCRJ330 RES-MET RN -C	3235003J0330	1	
28	R58~R60,R503~R507, R511~R514,R518	CR/RK73K/ERJ/MCRJ332 RES-MET RN -C	3235003J0332	13	
29	R61,R529~R531	CR/RK73K/ERJ/MCRJ333 RES-MET RN -C	3235003J0333	4	
30	R31	CR/RK73K/ERJ/MCRJ362 RES-MET RN -C	3235003J0362	1	
31	R68,R528	CR/RK73K/ERJ/MCRJ512 RES-MET RN -C	3235003J0512	2	
32	R54,R55,R523,R538	CR/RK73K/ERJ/MCRJ680 RES-MET RN -C	3235003J0680	4	
33	R525	RM73B2A201F RES-MET RN -C	323A5003F0201	1	
34	R524	RM73B2A621F RES-MET RN -C	323A5003F0621	1	
35	R23	RM73B2A101J RES-MET RN -C	323A5003J0101	1	
36	R5,R10	2125JPW RES-MET RN -C	323A5003P0001	2	
37	R536,R537	RM73B2B220J RES-MET RN -C	323A5015J0220	2	
38	R3	ERJ-12YJ750 RES-MET RN -C	323A5019J0750	1	
39					
40	R1,R2	RNS1-0.51ΩJ RES-MET OX	324A1012J0518	2	

**U8S Printed Circuit Board Rev. 1
(41222702YA-2/2-3/5)**

REF. No.	SYMBOL	TYPE/NAME	PART NO.	Q'TY	REMARKS
41					
42	R42~R45,R52,R56,R65, R70,R517,BF501	CR/RK73Z/ERJ/MCRJ-0V RES-Zero Ω -C	3255003P0001	10	
43	RM5~RM8	MNR14ABJ151 RES-Block -C	334A5012J0151	4	
44	RM1~RM4	MNR14ABJ680 RES-Block -C	334A5012J0680	4	
45	C504	GRM/UMK/MCH/470CH CAP-Ceramic -C	3033003C0470	1	
46	C512,C513,C539	GRM/UMK/MCH/102B CAP-Ceramic -C	50V 3036003K0102	3	
47	C509,C542	GRM/UMK/MCH/222B CAP-Ceramic -C	50V 3036003K0222	2	
48	C9,C10,C12,C14,C15	GRM/TMK/MCH/223B CAP-Ceramic -C	25V 3036003K0223	5	
49	C13	GRM/TMK/MCH/473B CAP-Ceramic -C	25V 3036003K0473	1	
50	C3~C6,C503,C506, C518,C532	GRM/UMK/MCH/103Z CAP-Ceramic -C	50V 3036003Z0103	8	
51	C11,C16~C20,C501, C502,C505,C507,C508, C510,C511,C515~C517, C519~C522,C524~C529, C533,C536~C538,C540	GRM/TMK/MCH/104Z CAP-Ceramic -C	25V 3036003Z0104	31	
52	C530	GRM/LMK/MCH/105Z CAP-Ceramic -C	10V 3036003Z0105	1	
53	C1,C2,C523,C531	CK2012F1H103Z CAP-Ceramic -C	50V 303A6008Z3103	4	
54	C8,C514	CK2012F1H104Z CAP-Ceramic -C	50V 303A6008Z3104	2	
55	CP1,CP4	UVX/SME-16V-47μF CAP-Alum(CE) -P	16V 3041003C1470	2	
56	CP2	KME50VB-47 CAP-Alum(CE) -47μF	50V 304A1115H1470	1	
57	CP3	UVS1A332MHA CAP-Alum(CE)	10V 304A1137A1332	1	
58					
59	IC3	SN74LVC161284DGGR Digital IC-MOS-S	7022350N1284	1	

**U8S Printed Circuit Board Rev. 1
(41222702YA-2/2-4/5)**

REF. No.	SYMBOL	TYPE/NAME	PART NO.	Q'TY	REMARKS
60	IC4	74HC244FP Digital IC-MOS-S	702A1703N0244	1	
61	IC9	TL431CLP/NJM431L-T3 Analog-BIPLIN -P	7200903M9001	1	
62	IC8	UPC393G2 Analog-BIPLIN -S	720A0523N0011	1	
63	IC10	PST592D-2 Analog-BIPLIN	720A4037M0015	1	
64	IC6	OR-Memory-MOSDRAM -S	41306901	1	
65	IC7	BR93LC66RF E2 Memory-MOSEEPR -S	8162331N0000	1	
66	IC5	ML60851DGA CPU-Interface -F	8550024N0002	1	
67	IC1	ML66921-014TC CPU-MOS(ROM) -F	8530324N0001	1	
68	IC2	MTD2007F-4072 Analog-BIPLIN -B	7201816N0001	1	
69					
70	EM1	ZJSC-2R2-101 COMP PAR-LC	342A1012P2101	1	
71	EM2	DSS306-0AE222Z COMP PAR-LC	342A1009P2222	1	
72					
73	Q4,Q6~Q8	2SA1331/2SA1037K TR-PNP/H FREQ -C	600A1003N0002	4	
74	Q501	A1344/UN2111/DTA114K TR-PNP/H FREQ -C	600A1003N0003	1	
75	Q3	2SA1338/2SB1198KT TR-PNP/H FREQ -C	6001003N0002	1	
76	Q5	2SC3361/2SC2412KVL TR-NPN/H-FREQ -C	602A1003N0002	1	
77	Q2	DTC123YKAT146 TR-NPN/H-FREQ -C	6021035N0019	1	
78	Q1	2SD1472 TR-NPN/L-FREQ -C	603A1121N0007	1	
79	TR1	2SD1623S TR-NPN/L-FREQ -C	603A1132N0001S	1	

**U8S Printed Circuit Board Rev. 1
(41222702YA-2/2-5/5)**

REF. No.	SYMBOL	TYPE/NAME	PART NO.	Q'TY	REMARKS
80					
81	CN3	57RE-40360-830B-D29 Connector-SQR	2201001P0360	1	
82	HEAD	SLD14S-2 Connector-PCB	2243001P0140	1	
83					
84	CN6	UBB-4R-D14T-1 Connector-PCB	2243023P0040	1	
85	CN5	06FE-ST-VK-N Connector-PCB	2244101P0060	1	
86	CN4	23FE-ST-VK-N Connector-PCB	2244101P0230	1	
87	CN2	00-8263-0212-00-000 Connector-PCB	224A3357P0020	1	
88	CN1	00-8263-0412-00-000 Connector-PCB	224A3357P0040	1	
89	CN7	B8B-XH-A Connector-PCB	224A3530P0080	1	
90					
91	OSC1	CST15.97MXW040 OSC-Ceramic	381A1047B0004	1	
92	OSC2	CSTCW4800MX41016-T OSC-Ceramic -C	3815000C0002	1	
93					
94	FU1	251-001 FUSE	540A2208S1102	1	
95					
96		TW-VF-23-0.1X0.8-210 CONN PAR	2381004P0009	1	
97		TW-VF-6-0.1X0.8-85 CONN PAR	2381015P0001	1	
98		MPS-04-0 Fastener	143A1047P0001	1	

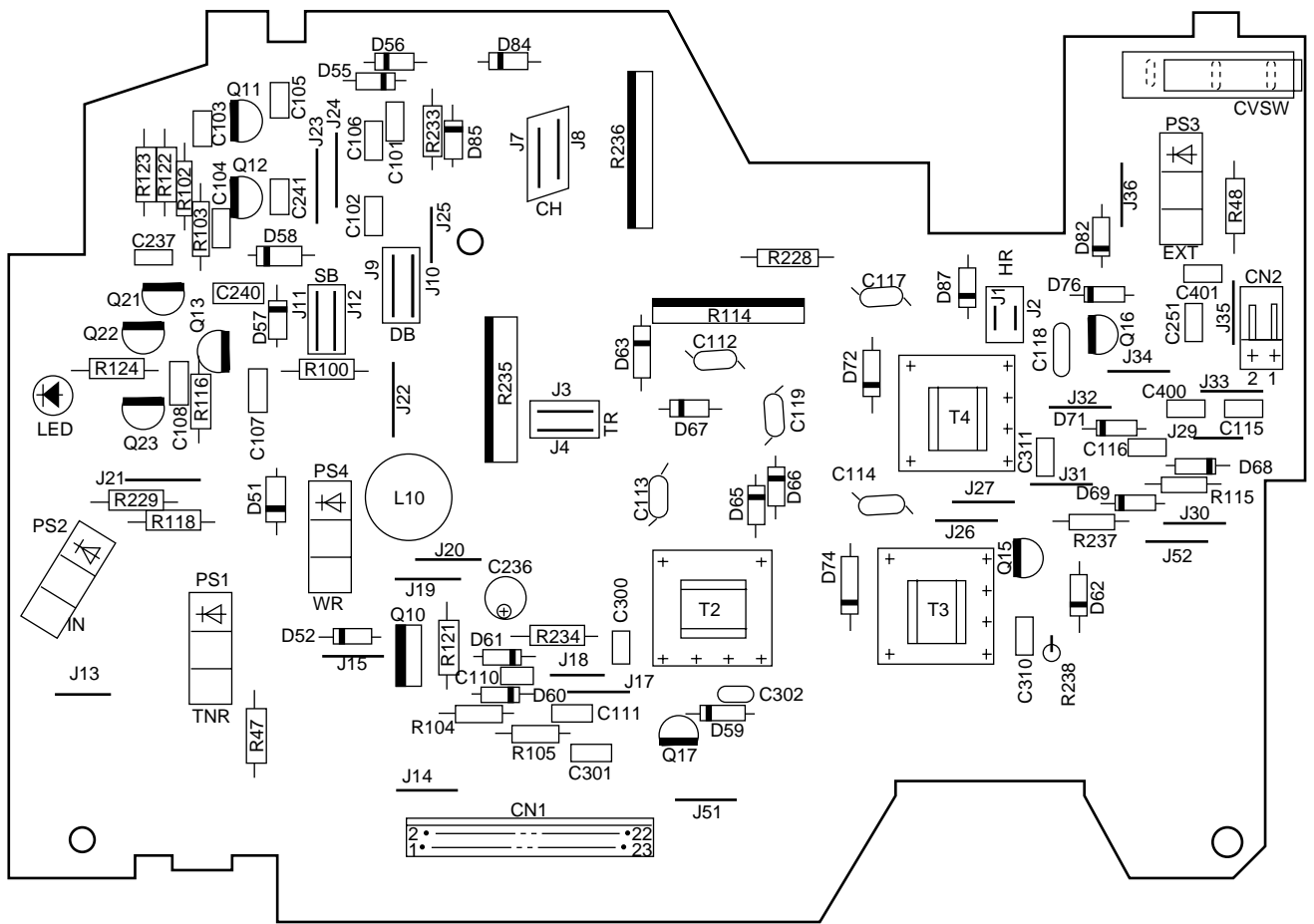

**P3H Printed Circuit Board Rev.1
(41039301YA-1/2)**

**P3H Printed Circuit Board Rev. 1
(41039301YA-2/2-1/3)**

REF. No.	SYMBOL	TYPE/NAME	PART NO.	Q'TY	REMARKS
1	D60,D61,D68,D69	1S953/1S2075K/1S2473 D-Signal -	611A0003L0001	4	
2	D63,D67,D72,D74	OR-DHM/ESJA/SHV-06	40681301	4	
3	D51,D55~D59,D62, D71,D84	EU02A/RL105F-F D-Rectifying -Q	6100003M0001	9	
4	D52	1ZB300-Y/Z D-Zener -	613A2003M0001	1	
5	D65,D66	1ZB390 D-Zener -	613A2258M0350	2	
6	D76	RD22E-B2 D-Zener -	613A1231L0262B	1	
7	D82	RD27E-B1 D-Zener -	613A1231L0282A	1	
8	D87	RD200E-B D-Zener -	613A1231L0522	1	
9	D85	1ZB270-Y/Z (TPA2) D-Zener -Q	6132003M0001	1	
10					
11	R234	RD1/4Y33ΩJ RES-Carbon flm -	321A1421J0330	1	
12	R47,R48	RD1/4Y130ΩJ RES-Carbon flm -	321A1421J0131	2	
13	R102,R116,R121	RD1/4Y330ΩJ RES-Carbon flm -	321A1421J0331	3	
14	R103,R123	RD1/4Y1KΩJ RES-Carbon flm -	321A1421J0102	2	
15	R118	RD1/4Y4.7KΩJ RES-Carbon flm -	321A1421J0472	1	
16	R122,R124,R229	RD1/4Y5.1KΩJ RES-Carbon flm -	321A1421J0512	3	
17	R105	RD1/4Y16KΩJ RES-Carbon flm -	321A1421J0163	1	
18	R104	RD1/4Y82KΩJ RES-Carbon flm -	321A1421J0823	1	
19	R235	RD1/4Y100KΩJ RES-Carbon flm -	321A1421J0104	1	
20	R228,R233	RD1/4Y1MΩJ RES-Carbon flm -	321A1421J0105	2	

**P3H Printed Circuit Board Rev. 1
(41039301YA-2/2-2/3)**

REF. No.	SYMBOL	TYPE/NAME	PART NO.	Q'TY	REMARKS
21	R100	RD1/4Y3MΩJ RES-Carbon flm -	321A1421J0305	1	
22	R115	RNL1/4C3F390KΩ RES-MET RN -	323A1222F0394	1	
23	R114,R236	MRH100MK/HV-38-100MK RES MET solid -	3263103K0107	2	
24	R237	RD1/4Y5.1ΩJ RES-Carbon flm -	321A1421J0519	1	
25	R238	RD16UJ1.5KΩ RES-Carbon flm -	3213420J0152	1	
26					
27	C105,C107,C119,C240, C241	HNY5P/DE07-1KV-471K CAP-Ceramic -P	3024003K7471	5	
28	C113,C114,C117	DE07/HCYB3F471 CAP Ceramic -Z	3024203K2471	3	
29	C112	DE1010B471K6K CAP-Ceramic -	6KV 302A4028K4471	1	
30	C101,C102,C106	HLY5P/DD05-500V-471K CAP-Ceramic -P	3024003K6471	3	
31	C103,C104,C108,C110, C111,C115,C237,C251, C300,C301,C311,C400, C401	MLRD/FK16Y5V1H104Z CAP-Ceramic -N	3034003Z3104	13	
32	C116	MLRD/FK16Y5V1H473Z CAP-Ceramic -N	3034003Z3473	1	
33	C118	MY2A/CQMF-ECQP-103J CAP-Plast flm -P	3064003J2103	1	
34	C302,C310	CQMF/MY2A/ECQP-472J CAP-Plast flm -P	3064003J2472	2	
35	C236	UVX/SME-63V-10μF CAP-Alum (CE) -P	63V 3041003J1100	1	
36					
37	Q11,Q13	BCR1AM-12/MAC97-008 THY-Bi/Dir -	622A0003M0001	2	
38	Q12	CR04AM-12 THY-Gate -	620A0022M0008	1	
39	Q21~Q23	2SC1815-Y/2SC5343Y-T TR-NPN/H-FREQ -P	6021003M0001	3	

**P3H Printed Circuit Board Rev. 1
(41039301YA-2/2-3/3)**

REF. No.	SYMBOL	TYPE/NAME	PART NO.	Q'TY	REMARKS
40	Q15~Q17	2SC2235-Y TR-NPN/H-FREQ -	602A1125M0039Y	3	
41	Q10	2SC2752 TR-NPN/H-FREQ -	602A1223M0039	1	
42					
43	L10	C-14576/SA-8506183 Coil-Choke -	3502003P0102	1	
44					
45	T2~T4	HIGH VOLTAGE TRANS- FORMER	4YB4049-7078P003	3	
46					
47	PS1~PS4	RPI-574/#9568 PHOTO-Coupler -	652A0103M0002	4	
48					
49	CVSW	SM05S/SS5GL13 Switch-Micro -	2071003P0001	1	
50					
51	LED	SEL3410G-YZ PHOTO-LED -	650A0329M0018	1	
52					
53	CN1	23FE-BT-VK-N Connector-PCB -	224A4134P0230	1	
54	CN2	53254-0210 Connector-PCB -	224A4407P0020	1	
55					
56	J1,J2	SHORT WIRE	TA-0.6	2	L=55mm P=5.0
57	J3,J4,J7~J12	SHORT WIRE	TA-0.6	8	L=55mm P=7.5
58	J13~J15,J17~J21,J23~ J27,J29~J36,J51,J52	SHORT WIRE	TA-0.6	23	L=55mm P=10.0
59	J22	SHORT WIRE	TA-0.6	1	L=55mm P=12.5

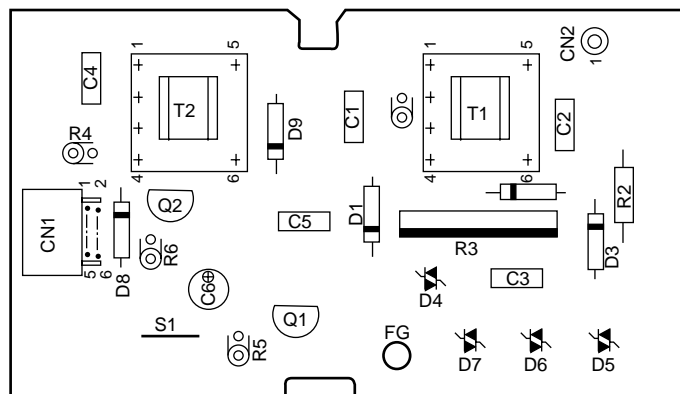

**P6L Printed Circuit Board Rev.2
(40605601YA-1/2)**

**P6L Printed Circuit Board Rev. 2
(40605601YA-2/2)**

REF. No.	SYMBOL	TYPE/NAME	PART NO.	Q'TY	REMARKS
1	D1,D8	EU02A/RL105F-F D-Rectifying -Q	6100003M0001	2	
2	D2,D3,D9	OR-DHM/ESJA/SHV-06	40681301	3	
3	D4	ERZV05D391 SEMICO-Vari -	6320229M0003	1	
4	D5~D7	ERZ/JVR-05N471 SEMICO-Vari -	6320003M0001	3	
5					
6	R1,R4~R6	RD16U/VTJ5.1KΩ RES-Carbon flm -	3213420J0512	4	
7	R2	RD1/4Y1MΩJ RES-Carbon flm -	321A1421J0105	1	
8	R3	MRH100MK/HV-38-100MK RES-MET solid -	3263103K0107	1	
9					
10	C1,C4	MY2A/CQMF-100V-103J CAP-Plast flm -P	3064003J2103	2	
11	C2,C3,C5	DE07/HCYB3F471 CAP-Ceramic -Z	3024203K2471	3	
12	C6	UVX/SME-63V-10μF CAP-Alum(CE) -P	63V 3041003J1100	1	
13					
14	S1	SHORT WIRE	TA-0.6	1	
15					
16	Q1,Q2	2SC2235-Y TR-NPN/H-FREQ -	602A1125M0039Y	2	
17					
18	T1,T2	HIGH VOLTAGE TRANS- FORMER	YB4049-7078P0003	2	
19					
20	CN1	06FE-ST-VK-N Connector-PCB -	2244101P0060	1	
21	CN2	RT-01T-1.0B Connector-PCB -	2247000P0001	1	